

**MADE IN GERMANY**

**KRAIBURG**

## Rubber covers for floors in cattle houses



**KRAIBURG**

► brings the pasture indoors



## ▶ Cow comfort - soft rubber coverings for lying, walking and standing

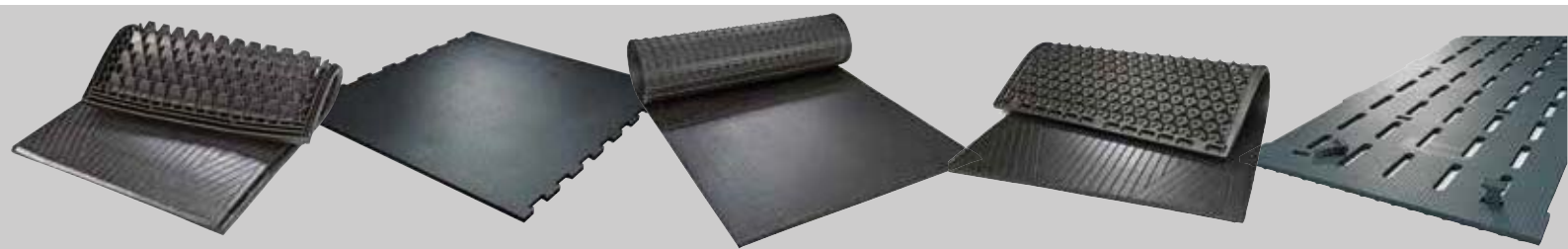

- ▶ easy installation
- ▶ long-lasting ideal softness
- ▶ sophisticated details
- ▶ dimensionally stable
- ▶ slip-resistant

If flooring in cattle houses was as soft as in nature, conditions for cows would be more comfortable and healthier.

After all, the cows use the floor in the cattle house 24 hours a day for lying, standing and walking.

### The cow needs animal-friendly lying and walking areas:

- ▶ permanently soft
- ▶ hygienic
- ▶ slip-resistant

= **pre-requisite for high productivity and longevity**

### Higher milk yield due to animal-friendly lying and walking areas



Source: Eelkema, W., Heikamp, R., Hopster, H., 2004

### Our solution:

rubber coverings for every application in the cow house, especially developed for and optimally adapted to the particular demands.



		page	
<b>Introduction</b>	Which products do we produce?	▶ 2	
	Contents & product overview	▶ 3	
	About KRAIBURG	▶ 4	
	General product data: warranty, installation, tolerances	▶ 5	
<b>Lying areas</b>	<b>Dairy cow cubicle house</b>		
	Basics	▶ 6	
	KEW Plus	★★★★★ ▶ 8	
	WINGFLEX	★★★★★ ▶ 9	
	KKM	★★★ ▶ 10	
	KKM LongLine	★★★ ▶ 11	
	ergoBOARD	brisket board ▶ 12	
	maxiBOARD	brisket board ▶ 13	
	maxiBOX	comfort deep litter cubicle ▶ 14	
	<b>Young cattle</b>		
	KIM LongLine	★★★ ▶ 16	
	CALMA	★★ ▶ 17	
	<b>Walking &amp; milking area</b>	<b>Dairy cow cubicle house</b>	
		Basics	▶ 18
KURA S		slatted floor ▶ 20	
KURA P		paved/concrete floor with scraper ▶ 21	
KURA Flex / Form		paved/concrete floor without scraper ▶ 22	
KURA Rotary		rotary parlour carousels ▶ 23	
pediKURA® system		soft walking area with abrasion zones ▶ 24	
<b>Workplace milking area</b>			
ergoMILK		ergonomic mat for the milking pit ▶ 26	
<b>Pens / special areas</b>		<b>Young cattle - slatted floor</b>	
		LOSPA swiss	pens ▶ 27
		<b>Calving pen / quarantine</b>	
	VITA	★★★★★ ▶ 28	
	SIESTA	★★ ▶ 29	
	<b>Tying stalls / feed stalls</b>	LENTA	★★ ▶ 30
KEN		★ ▶ 31	

When we offer you several products for the same application, you can see our evaluation on cow comfort with the ★-symbols.



## ► Our experience is your gain

### KRAIBURG group

KRAIBURG has established itself as an expert specialist in the rubber business. The KRAIBURG Holding GmbH & Co. KG has a staff of more than 1,800 employees worldwide, mainly in Germany, Austria and Switzerland. It holds branches in further European countries as well as in Asia and North America.



### High quality rubber materials

Rubber mats are subject to extremely high stress in agriculture. We have been manufacturing high-quality rubber mixtures with a unique process for over 40 years. Experience will tell you that not all rubber mats are the same.



### KRAIBURG housing floor technology with quality

Since 1968 we have been developing and manufacturing rubber floor mats for animal houses in Germany. Today about 180 employees exclusively concentrate on that. Our goal is to achieve more than just fulfilling the general legal requirements – we are certified with the worldwide ISO 9001 standard and operate an inhouse laboratory. We test our products together with the DLG (German Agricultural Society – incorporated society) – results at [www.dlg.org](http://www.dlg.org).

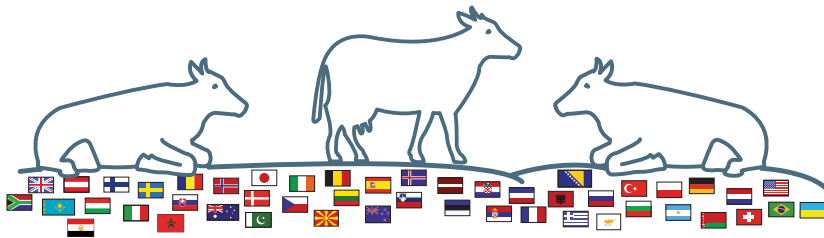

Have you got any questions?  
We look forward to hearing from you!



You can call us at: +49/8683/701-303  
(We speak English, German, Russian)



## KRAIBURG manufacturer guarantee

Our name stands for quality. We guarantee as a German manufacturer that our products will function reliably for many years.

Products	KRAIBURG manufacturer guarantee*
KEW Plus	rubber: 10 years foam: 5 years
WINGFLEX	10 years
KKM / KKM Puzzle / KKM LongLine	10 years
maxiBOX	10 years
KIM LongLine	10 years
CALMA (Puzzle)	10 years

Only for exclusive use as cubicle covering, no combinations, e.g. feeding+lying

\* More detailed information is available on request. Please pay attention to the information on the respective product pages.

Products	KRAIBURG manufacturer guarantee*
KURA S	5 years
KURA P	5 years
KURA Flex / KURA Form / KURA Rotary	5 years
pediKURA®	5 years
LOSPA swiss	5 years
VITA	5 years
SIESTA	5 years
LENTA	10 years
KEN / KEN Puzzle	10 years

## Installation - easy and fast

The installation of the KRAIBURG mats is easy and fast. Nevertheless, it is important to **pay attention to specific guidelines** as well as to the **correct installation!**

The guidelines to correct installation can be found in the installation instructions of the respective products. These are available in many languages.

You will obtain these with the delivery, at your local KRAIBURG dealer or at [www.kraiburg-elastik.com](http://www.kraiburg-elastik.com). You can also watch installation videos of many products on our website.



installation instructions

## Maintenance - minimum working time

Our recommendation: spread a small amount of litter on the lying mats, e.g. soft milled straw or mineral material. (Moisture in the lying area, among other things, plays a major role in the development of skin diseases and infections!)

For cleaning the walking area floorings the combination with scraper manure removal systems has already been proven in practice (adapt scraper facilities according to our specifications and control them regularly). We recommend to keep the walking areas as clean and dry as possible. (Important for claw health and slip resistance!)

Our products can be kept clean with high-pressure cleaner as well as standard cleaning agents.



installation videos

## Tolerances for KRAIBURG mats

**thickness:** +3/-2 mm      **length + width:** +/- 1.5 % (DIN ISO 3302-1 tolerance class M4)

The tolerances also apply within the mat and when installed.

More technical details on request. The products presented here should only be used for the mentioned applications. Technical specifications are subject to alterations. All sales are subject to our General Terms and Conditions. Legal basis is the German version of the document.

## KRAIBURG mats - advantages at a glance

What characterises KRAIBURG lying coverings?



safe standing on the mat

■ many **additional functions**:

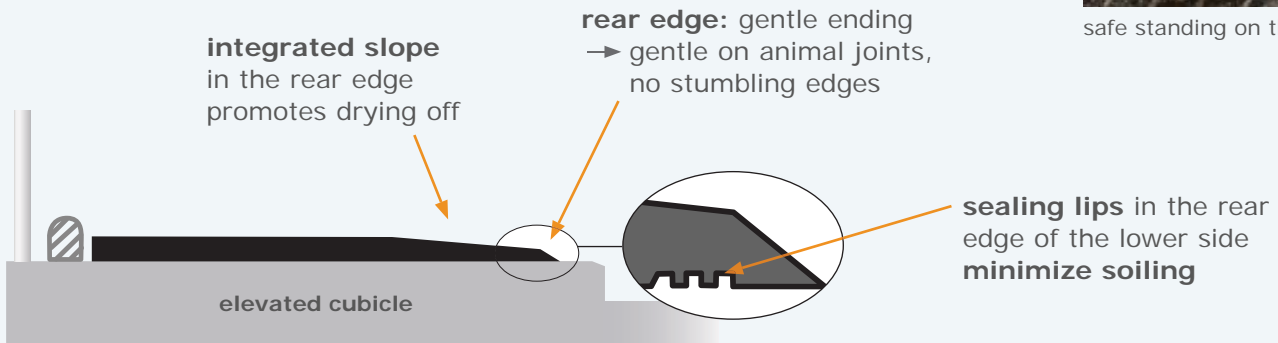

- **elastic surface** (specially for the softest single mats):
  - ▶ groove profile additionally promotes the drying of the surface
  - ▶ rear diagonal grooves: additional support for standing up and lying down
  - ▶ exceptionally comfortable and eudermic
- **optimal resilience** → sinking in of the claw enhances **slip-resistance**
- **outstanding rubber mixture** → **ideal quality - rugged and permanently soft**
- **minimum time and effort for maintenance**

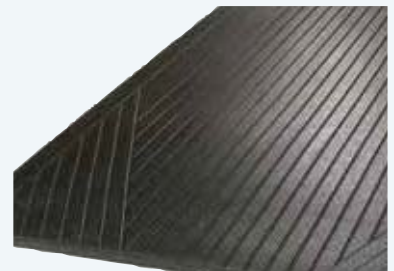

elastic surface

## Caring for joints – well-being

KEW Plus: assessing joint condition

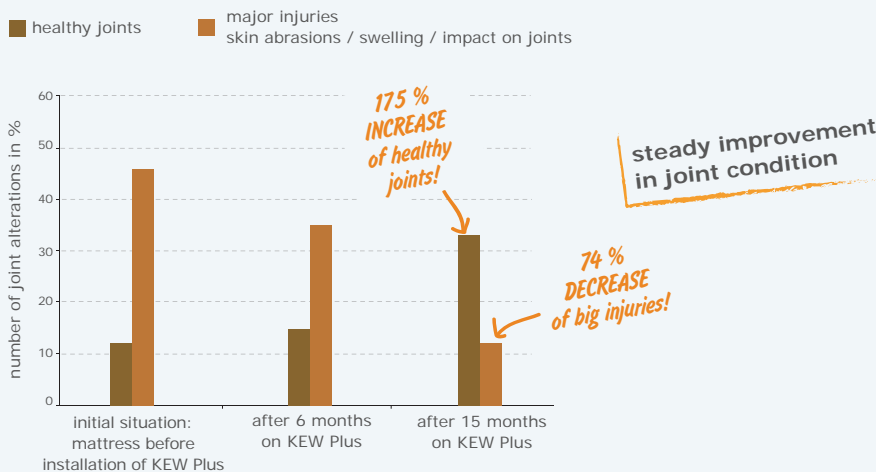

Source: Mathis, A., 2006

Anatomical background

Hock joint on hard lying surface: the weight burden on one spot



→ disturbed blood flow, damage to the roots of the hair and to the skin

Hock joint on soft lying surface: the weight is distributed to a larger surface

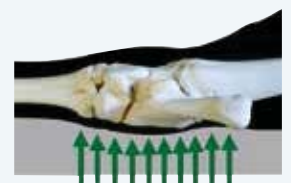

→ caring for joints

## Softness & durability

### Loss of softness after long-term test

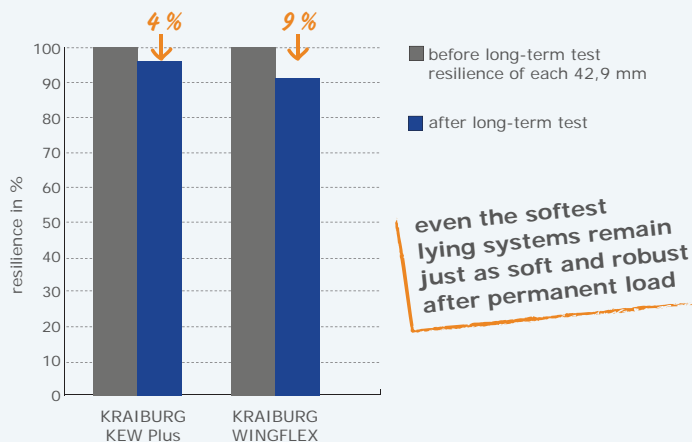

Source: test according to DLG, 2008, 2009

even the softest lying systems remain just as soft and robust after permanent load

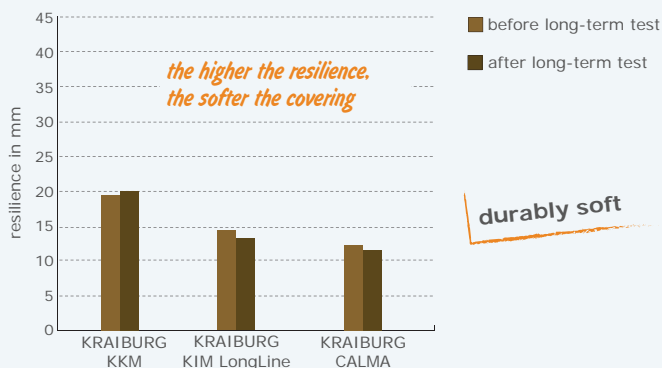

Source: KRAIBURG laboratory, 2008, 2010 (compare it with DLG test reports - www.dlg.org)

the higher the resilience, the softer the covering

durably soft

## Ideal balance between heat insulation and dissipation

### Heat flow of various lying areas

#### Heat dissipation – thermoregulation of the cow

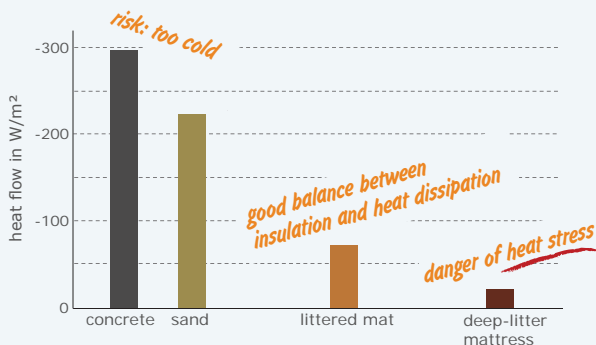

Source: Kramer, A.J., 2001

littered mat: ideal thermal balance - in summer as well as in winter



4 seasons in the cattle house

## Economic efficiency

### Higher milk yield on a soft KRAIBURG mat

Comparing lying areas:

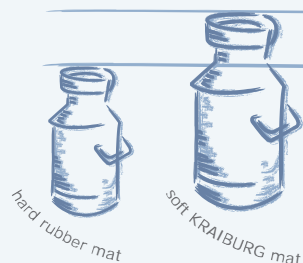

about 1.5 kg per cow per day MORE MILK

Source: LfL Saxonia, 1999

### Low litter requirements and minimal labour input for maintenance

#### Straw requirements per cow per year

Elevated cubicle with KRAIBURG mat:	∅ 40 kg
Deep-litter cubicle with straw:	∅ 260 kg

#### Labour requirements per cow per year

Elevated cubicle with KRAIBURG mat:	∅ 95 min.
Deep-litter cubicle with straw:	∅ 265 min.

Source: Heidenreich, T., 2007

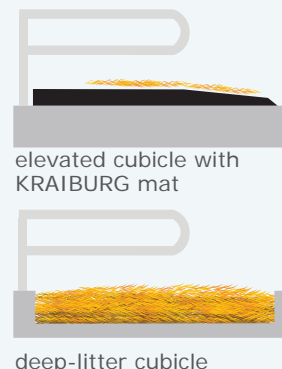

elevated cubicle with KRAIBURG mat

deep-litter cubicle



KEW Plus

Softness: ★★★★★

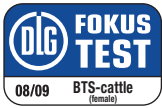

the benchmark for excellent lying comfort for ten years

- the three functional layers ensure optimal and permanent softness for every load condition
- the soft lying area within the mat edges supports the correct resting position of the cow and improves slip resistance
- comfortable and eudermic elastic surface
- integrated soft slope to rear edge promotes drying off
- chamfer at rear edge → gentle on animal joints, no stumbling edge

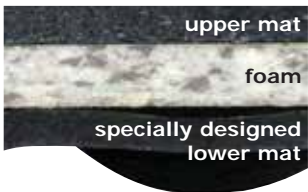

3 functional layers:  
6 cm highest lying comfort



sealing lips completely surround the foam inlay and the lower mat



connecting bar engages flush with the surface and facilitates professional installation

System dimensions:

thickness: approx. 60 mm	width: adjustable with connecting bar	mat width:	107 cm	112 cm	112 cm	112 cm	length: 183 cm 192 cm (from 120 cm width)
		profile width:	+ 8 cm	+ 8 cm	+ 13 cm	+ 18 cm	
		↓					
		cubicle width:	115 cm	120 cm	125 cm	130 cm	

Installation: 2 fixings / mat and 5 screws / profile\*

Accessories:

- end-profile** - for closure at side edges of the cubicle row, **width:** 63 mm, **length:** 183 mm
- ergoBOARD** - the flexible brisket board (see page 12)
- maxiBOARD** - the robust brisket board (see page 13)

\* Please take notice of the corresponding KRAIBURG installation instructions with useful advice and tips. You will obtain these at your local KRAIBURG dealer or at [www.kraiburg-elastik.com](http://www.kraiburg-elastik.com).



WINGFLEX

Softness: ★★★★★



excellent cost-comfort ratio

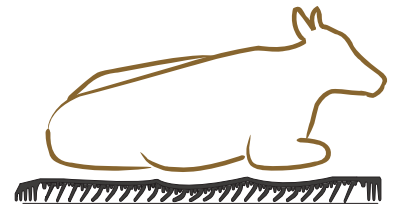

mat adapts to the lying cow

- innovative wing profile creates high permanent softness → adapts optimally to body shape
- comfortable and eudermic elastic surface
- integrated soft slope to rear edge promotes drying off
- chamfer at rear edge → gentle on animal joints, no stumbling edge



supporting studs have a cushioning effect at concentrating loads (when the cow gets up or lies down)



a profile element (wing+ supporting studs): extremely stable, wear resistant and flexible simultaneously



minimized soiling underneath the mat due to completely surrounding sealing lips



indented connecting bar engages flush with the surface and engages in the countersinks on the mat's edge → facilitates professional installation



System dimensions:

thickness: approx. 60 mm	width: adjustable with connecting bar	mat width:	102 cm	102 cm	112 cm	112 cm	112 cm	length: 183 cm
		profile width:	+ 8 cm	+ 13 cm	+ 8 cm	+ 13 cm	+ 18 cm	
		↓	↓	↓	↓	↓	↓	
		cubicle width:	110 cm	115 cm	120 cm	125 cm	130 cm	

Installation: 2 fixings / mat and 5 screws / profile\*

Accessories:

- end-profile - for closure at side edges of the cubicle row, width: 63 mm, length: 183 mm
- ergoBOARD - the flexible brisket board (see page 12)
- maxiBOARD - the robust brisket board (see page 13)

\* Please take notice of the corresponding KRAIBURG installation instructions with useful advice and tips. You will obtain these at your local KRAIBURG dealer or at [www.kraiburg-elastik.com](http://www.kraiburg-elastik.com).

KKM / KKM Puzzle

Softness: ★★ ★

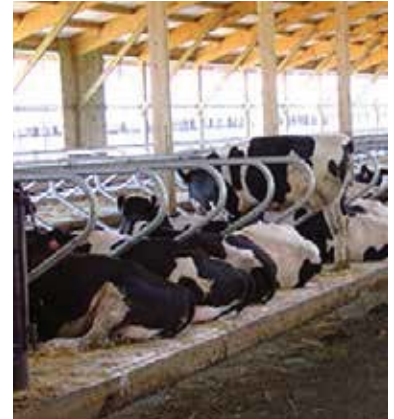

- the special honeycomb texture and different softness zones create excellent and permanent lying comfort
- comfortable and eudermic elastic surface
- integrated soft slope to rear edge promotes drying off



the **sealing lips** have proven themselves in practice



**minimized soiling** underneath the mat due to the **sealing lips** in the rear section

options:



with straight edges



with **KK-Poly-T-Bar** e.g. for stall equipment with mushroom dividers or especially when using very fine litter



with **puzzle shaped edges** and chamfer on the rear edge

**Dimensions:**

<b>thickness:</b> 30 mm	<b>KKM (straight edges):</b>	<b>KKM Puzzle:</b>	
	<b>width:</b> 110/115/120/125/130 cm	<b>width:</b> 110/120/125 cm	<b>length:</b> 170/183/200 cm
	<b>length:</b> 170/183/200 cm		

**Installation:** 3 fixings / mat\*

**Accessories:**

**KK-Poly-T-Bar** for covering joint widths of 40 - 80 mm or for closure at side edges, **length:** 120/165/180 cm,

**installation:** 4-5 screws / profile

**ergoBOARD** - the flexible brisket board (see page 12)

**maxiBOARD** - the robust brisket board (see page 13)

\* Please take notice of the corresponding KRAIBURG installation instructions with useful advice and tips. You will obtain these at your local KRAIBURG dealer or at [www.kraiburg-elastik.com](http://www.kraiburg-elastik.com).

## KKM LongLine

Softness: ★ ★ ★



- the special honeycomb texture and different softness zones create excellent and permanent lying comfort
- integrated soft slope to rear edge promotes drying off
- chamfer at rear edge → gentle on animal joints, no stumbling edge

Installation  
independent of  
divider arrangement!



proven **pebbled surface**

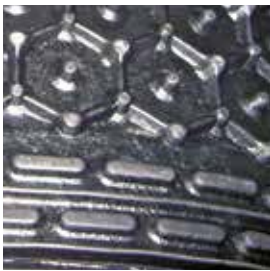

**minimized soiling**  
underneath the mat due  
to the **sealing lips** in  
the rear section



**chamfer at rear edge**

### Dimensions:

**thickness:** 30 mm    **length:** 2.5 - 50 m  
in 10 cm increments    **width:** 170/183/200 cm

**Installation:** only at the front edge 2-3 fixings per lying place\*

### Accessories:

**KK-Poly-T-Bar** for closure at side edges, **length:** 120/165/180 cm, **installation:** 4-5 screws / profile  
**ergoBOARD** - the flexible brisket board (see page 12)  
**maxiBOARD** - the robust brisket board (see page 13)

\* Please take notice of the corresponding KRAIBURG installation instructions with useful advice and tips. You will obtain these at your local KRAIBURG dealer or at [www.kraiburg-elastik.com](http://www.kraiburg-elastik.com).



**ergoBOARD** ▶ flexible brisket board made of rubber

research findings:  
20 % of the animals  
stretch out their foreleg  
in the pasture  
(Pelzer et al., 2007)

pleasantly soft contact area allows natural  
lying positions with foreleg stretched out

- complements ideally the cubicle's control devices
- flexible, comfortable and dimensionally stable
- allows relaxed changing of lying positions
- easy on carpal joints when getting up
- combination with various lying mat systems possible
- retrofitting easily possible



back side

**Dimensions:**

**length:** 115/120 cm

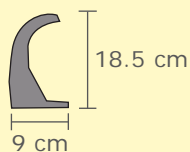

**Installation:** 5 fixings / piece\*

**Attention:** The installation of ergoBOARD is possible at a lying place width of at least 115 cm, as you need one ergoBOARD per cubicle.

\* Please take notice of the corresponding KRAIBURG installation instructions with useful advice and tips. You will obtain these at your local KRAIBURG dealer or at [www.kraiburg-elastik.com](http://www.kraiburg-elastik.com).



**maxiBOARD** ▶ robust brisket board made of rubber



- animal-friendly, flexible and robust
- **complements** ideally the cubicle's control devices
- facilitates different natural lying positions
- easy to put in litter from the head space
- combination with various lying mat systems possible
- ideal for 3 cm thick mats: mat and maxiBOARD are fastened at the same time
- easy retrofitting possible
- fits every cubicle width

**Dimensions:**

**length:** 175 cm

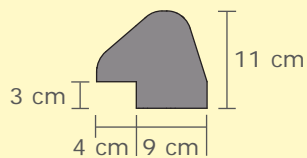

**Installation:** 7 fixings / piece\*

**Accessory:**

**plastic board** as shim for the maxiBOARDS for installation on mats with a thickness of 6 cm, **length:** 200 cm, **installation:** is fastened with maxiBOARD at the same time

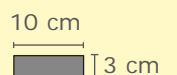

\* Please take notice of the corresponding KRAIBURG installation instructions with useful advice and tips. You will obtain these at your local KRAIBURG dealer or at [www.kraiburg-elastik.com](http://www.kraiburg-elastik.com).

**maxiBOX** ▶ comfort deep litter cubicle

- 3-component system consisting of rubber cover (roll) + rubber brisket board + rubber profile at rear curb
- ensures year-round functional safety → consistent comfort
- recommended littering depth: 3 - 5 cm

**maxiLONGLINE - rubber cover (roll):**

- lasting softness through a pliant and highly wear resistant air cushioned profile
- integrated slope at the rear, as well as drainage grooves and openings, facilitate liquid drainage flow
- intelligent surface profile retains litter especially well, is slip-resistant when getting up or lying down

**maxiSTEP - rubber profile at rear:**

- elastic and ergonomically chamfered for comfortable lying down and lying
- litter losses are minimized
- integrated drainage for liquids
- robust, dimensionally stable and sure-footed

**maxiBOARD - rubber brisket board:**

- animal-friendly, elastic and robust
- easy to put in litter from the head space

**optional: maxiPROFIL - profile at side:**

- application as side lying area boundary recommended
- easy installation on the mat
- litter is better retained in the lying place

air cushion profile  
on lower side

surface

beginning layer  
formationmaxiSTEP  
(profile at rear)maxiBOARD  
(brisket board)maxiPROFIL  
(profile at side)

**maxiBOX** ▶ comfort deep litter cubicle

**Prerequisites for the concrete surface (lying area):**

- at least a 3 % slope
- about 10 cm high



**Dimensions:**

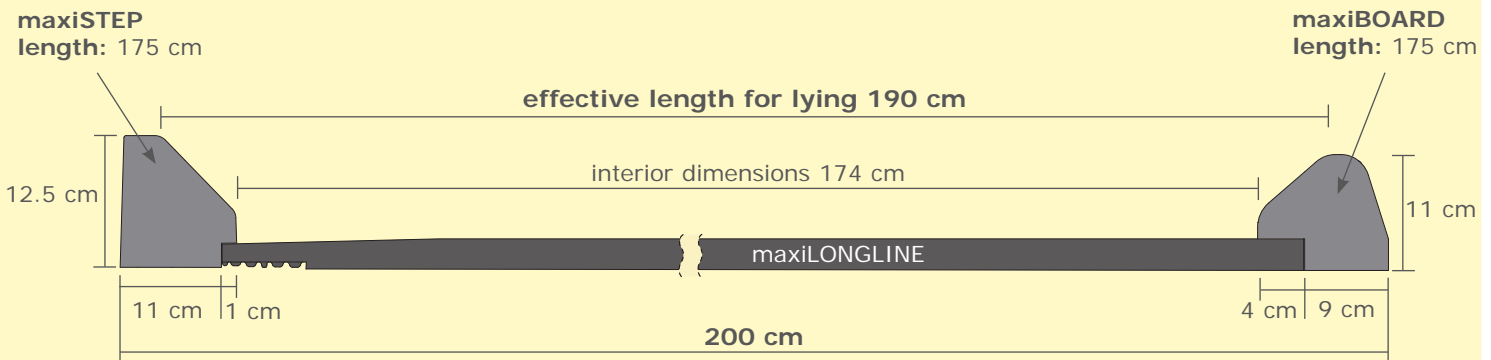

**maxiLONGLINE:**

**thickness:** 30 mm      **length:** 2.5 - 50 m  
in 10 cm increments      **width:** 180 cm (custom dimensions - e.g. for young cattle - on request)

**Installation:** 7 fastenings each for maxiBOARD and maxiSTEP, maxiLONGLINE is fastened at the same time with maxiBOARD on the concrete floor\*

**Accessory:**

**maxiPROFIL** for covering joints, for the side lying area boundary on maxiLONGLINE, for closure at side edges, **length:** 173 cm, **installation:** 5 screws / profile

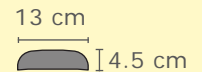

\* Please take notice of the corresponding KRAIBURG installation instructions with useful advice and tips. You will obtain these at your local KRAIBURG dealer or at [www.kraiburg-elastik.com](http://www.kraiburg-elastik.com).

## KIM LongLine

Softness: ★★☆☆



- the supple, highly wear resistant air cushion profile creates pleasant and permanent lying comfort
- integrated soft slope to rear edge promotes drying off
- chamfer at rear edge → gentle on animal joints, no stumbling edge



supple air cushion profile

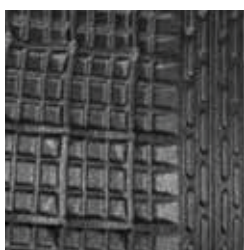

minimized soiling underneath the mat due to the **sealing lips** in the rear section

Installation independent of divider arrangement!

#### Dimensions:

<b>thickness:</b>	<b>length:</b>	<b>width:</b>
27 mm	2.5 - 50 m in 10 cm increments	160/170/180 cm

**Installation:** only at the front edge 2-3 fixings per lying place\*

#### Accessories:

**KK-Poly-T-Bar** for closure at side edges, **length:** 120/165/180 cm,

**installation:** 4-5 screws / profile

**ergoBOARD** - the flexible brisket board (see page 12)

**maxiBOARD** - the robust brisket board (see page 13)

\* Please take notice of the corresponding KRAIBURG installation instructions with useful advice and tips. You will obtain these at your local KRAIBURG dealer or at [www.kraiburg-elastik.com](http://www.kraiburg-elastik.com).



**CALMA**

Softness: ★ ★



- pleasant and permanent softness through air-cushion-like lower side profile
- sealing lips reduce soiling underneath the mat
- chamfer at rear edge → gentle on animal joints, no stumbling edge



air-cushion-like lower side profile: soft and sturdy



chamfer at rear edge

**Installation as a continuous system – independent of divider arrangement!**

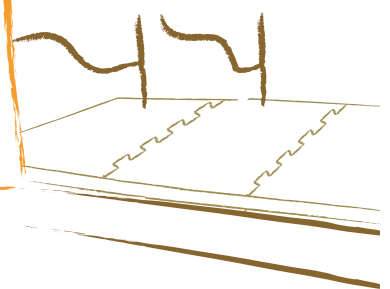

**Dimensions:**

**thickness:** 30 mm    **width:** 115 cm    **length:** 140/150/160/170/180 cm

**Installation:** 3 fixings / mat\*

**Accessories:**

**ergoBOARD** - the flexible brisket board (see page 12)  
**maxiBOARD** - the robust brisket board (see page 13)

\* Please take notice of the corresponding KRAIBURG installation instructions with useful advice and tips. You will obtain these at your local KRAIBURG dealer or at [www.kraiburg-elastik.com](http://www.kraiburg-elastik.com).

The KRAIBURG KURA mat - proven for more than ten years!

- sturdy and thick mats
  - ▶ permanently stable in position and form
- appropriate softness for the walking area
- no straining points, ideal load distribution
- simple and fast installation
  - ▶ mats are easy to handle
  - ▶ marked fixing points ease installation
- KRAIBURG fastening systems
  - ▶ stable and safe, flush with the mat
- tailor-made

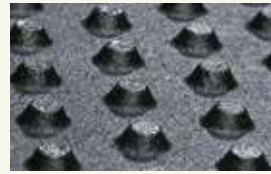

stud profile on lower side



grip-surface: supports sure footing



patented rubber peg

especially designed: rounded off and flush countersunk



The right softness makes all the difference

**Problem:** On hard floors claw damages often occur, more than 80 % of them on the outer claws of the hind legs.



**Background:**

The outer toe is approx. 3 mm longer by nature.



Source: Muggli, E., 2007

Natural ground contact of cattle:



The hind outer claw steps down first and therefore absorbs the peak load.



The inner claw takes the secondary impact – faster on a soft surface than on a hard surface.

Source: Schmid, T., Weishaupt, M.A., Meyer, S.W., Waldern, N., Peinen, K.V., Nuss, K., 2008  
Figures: Karl Nuss, Zurich

▶ **Floor requirements:** The claw sinks approx. 3 mm into the ground for optimal protection against overload

▶ **The soft KURA covering is especially adapted to the natural demands of the cow!**  
▶ suitable for new construction, as well as for renovation of slippery or claw-damaging floors

Claw health

Claw health  
KURA S rubber covering in comparison to concrete slatted floor

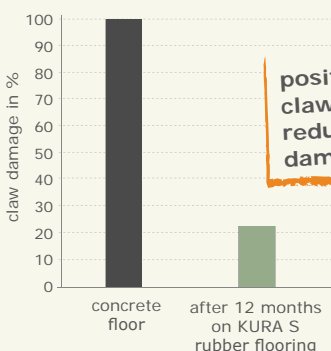

positive effect on claw health: drastic reduction of claw damage

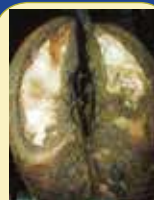

ideal shaping of the bearing rim

Pressure distribution on soft KURA rubber covering



pressure distribution of claws after 6 months exposure to walkways with soft rubber

measures show correct bearing pressure on the intact claw wall

Source: Benz, B., 2002

Source: Telezhenko, E., Bergsten, C., Magnusson, M., Ventorp, M., Nilsson, C., 2008

Natural animal behaviour – well-being

Bulling

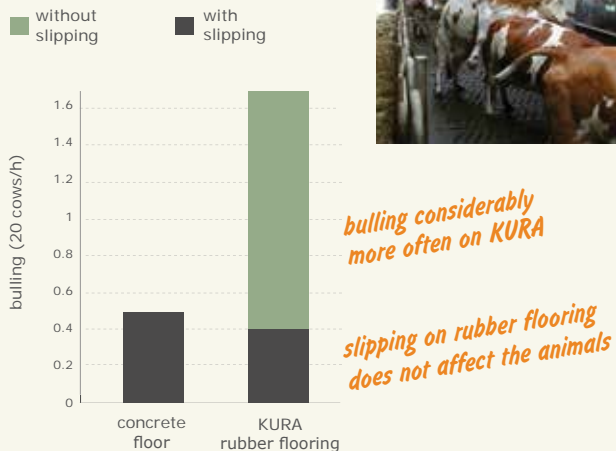

Caudal licking

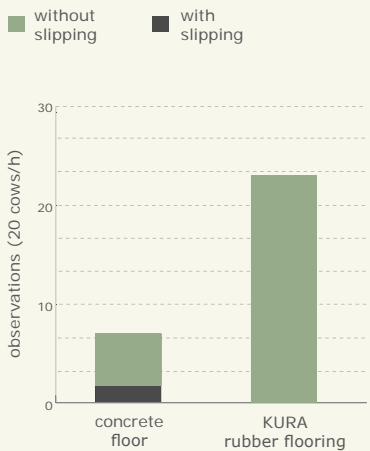

- ▶ claw sinks in
- ▶ hollow gives support
- ▶ cow feels safe

**grip-surface:** supports sure footing

the cows feel safe and have confidence in the KURA floor

the frequency of caudal licking has substantially increased

Source: Benz, B., 2002

Better mobility

Walking

covered walking distance

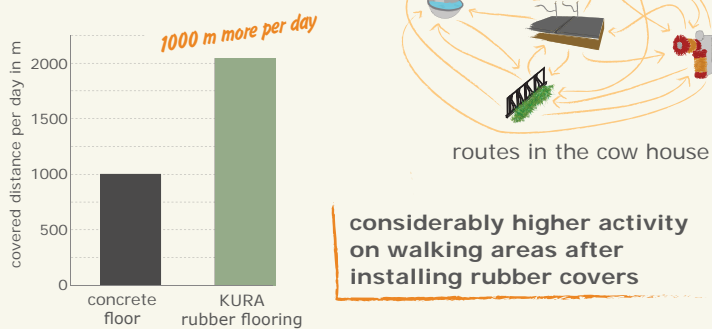

Hygiene

Germ climate in the cubicle housing system KURA S rubber flooring in comparison to concrete slatted floors

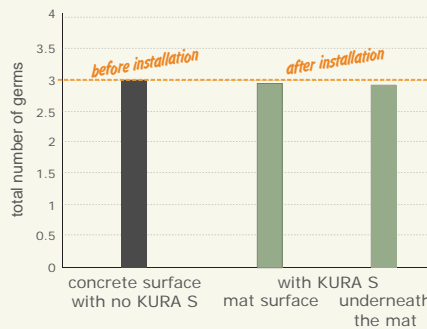

no higher germ formation on rubber mat surface and underneath the mat

Source: Benz, B., 2002

Source: Reiter, Partes, Koßmann, 2006

Economic efficiency

Costs for a claw ulcer treatment:

- Costs for treatment
- Less milk

At least 300 EURO for one claw ulcer

1.6 bn EURO damage through claw diseases / 10 - 15 % culling (EU)

Calving-to-conception intervals

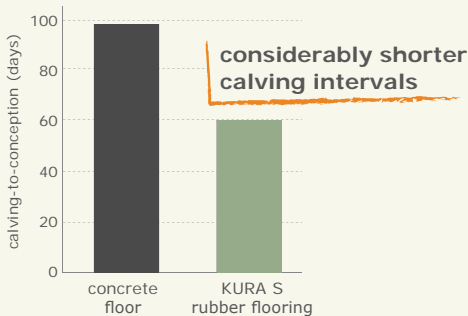

Source: Kremer et al., 2007

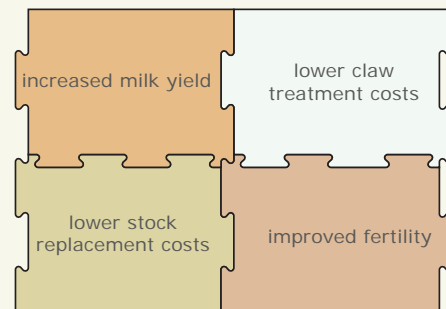

the investment in animal-friendly walking areas pays off

Source: Herrmann, 2006

**KURA S**

► claw-friendly and more slip-resistant cover for slatted floors



► **Tailor-made for every slatted floor geometry**

The mats are generally dimensioned according to the guidelines established by our specialists. The slatted floor must be suited for covering with KRAIBURG mats.\*

- improves claw health, productivity and longevity
- permanently stable in position and form
- compatible with use of manure scraper, robot scraper and wheeled traffic\*

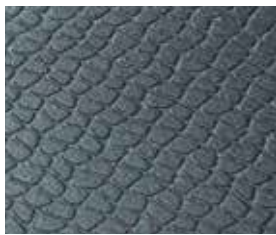

**grip-surface supports sure footing**



**stud profile** for ideal softness



**fastening element:** patented rubber peg to prevent lateral slipping - flush with the mat

**Dimensions:**

**lower side profile:** studs (5 mm)      **thickness:** 24 mm      **width and length:** tailor-made

19 mm 24 mm

**Important prerequisites for slatted floors:**

**slit width:** starting at 24 mm      **slat width within concrete elements:** starting at 80 mm

\* Please take notice of the corresponding KRAIBURG specifications. You will obtain these at your local KRAIBURG dealer or at [www.kraiburg-elastik.com](http://www.kraiburg-elastik.com).



**KURA P**

▶ claw-friendly and more slip-resistant cover for paved/concrete areas, with stationary scraper or mobile manure removal



▶ Fits very exactly – width can be adapted in 2 cm increments

- improves claw health, productivity and longevity
- permanently stable in position and form
- puzzle compensates for natural thermal expansion, practically a seamless floor area
- compatible with use of manure scraper and wheeled traffic\*



**grip-surface supports sure footing**



**stud profile** for ideal softness

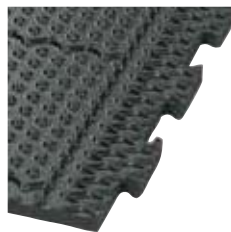

**reinforced puzzle-shaped edges**

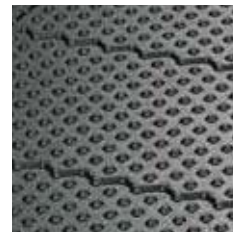

**dirt barriers** reduce soiling underneath the mats



**KRAIBURG fastening system:** extremely sturdy and rounded off



**Scraper manure removal**

The combination with scraper manure removal systems has already been proven in practice. Almost every scraper can easily be adjusted to operation with the KURA P, according to KRAIBURG's scraper guidelines.\* However co-ordination with the manufacturer of the scraper is required. Important: check any adaptations regularly! Well-known manufacturers of manure removal technology already keep scraper models authorized by us (no adaptation needed).

**Driving over**

Vehicle weight, tyre width and required tyre pressure are all related. Therefore, the **required inflation pressure of the authorized tyres is: maximum 4 bar**

**Dimensions:**

**lower side profile:** studs (5 mm)

**thickness:** 24 mm

**width:** in 2 cm increments from 96 cm to 500 cm (starting at a width of 350 cm, mats are puzzled together)



**length:** 125 cm

**Especially for areas with solar radiation:** KURA P SUN with expansion slits in the mat (see also leaflet „Special areas with KURA“)



\* Please take notice of the corresponding KRAIBURG specifications. You will obtain these at your local KRAIBURG dealer or at [www.kraiburg-elastik.com](http://www.kraiburg-elastik.com).

**KURA options** ▶ for areas like milking parlours, collecting yards, travel lanes, crossing passages, ... without scraper or mobile manure removal

- faster milking through improved parlour entrance and exit
- stress reducing (animals stand easy and relaxed)
- helps to reduce noise
- can be installed between milking times



**stud profile**  
for ideal softness

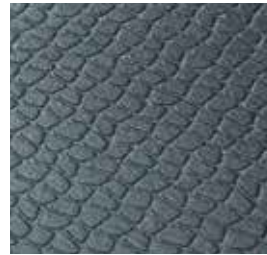

**grip-surface**  
supports sure footing

**a) KURA Flex** ▶ the flexible one

- available with puzzle shaped edges on 2, 3 or 4 sides
- through the versatile dimensions and combination possibilities, the most unusually shaped areas can be covered; the mats might only have to be cut to shape on the edges of the surface



**Dimensions:**



**lower side profile:** studs (5 mm)

**thickness:** 24 mm

**2 sides with puzzle shaped edges:** length: 125 cm x width: 87.5/92/96/100/104.5/109/113/117/121.5/126/130/134/138.5/143/147/151/155.5/160/164 cm  
(puzzle seam on wide sides)

**3 sides with puzzle shaped edges:** length: 125 cm x width: 82/99/116/133/150/167 cm  
(puzzle seam on wide sides and on one long side)

**4 sides with puzzle shaped edges:** length: 125 cm x width: 170 cm

**KURA options for special areas:**

Areas with **solar radiation:**   
**KURA Flex/Form SUN** (with expansion slits in the mat)

Areas with **flushing manure removal:**   
**KURA Flush**

(see also leaflet „Special areas with KURA“)

**Covering examples:**

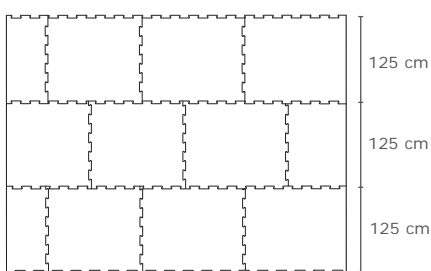

3 sides / 4 sides puzzle

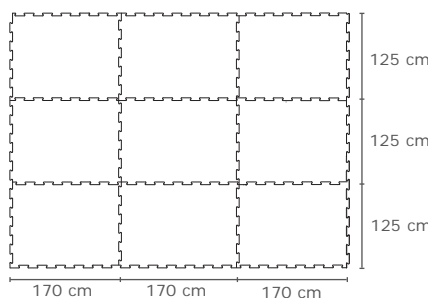

4 sides puzzle

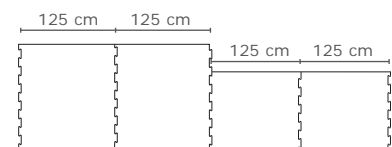

2 sides puzzle



**KRAIBURG fastening system:**  
extremely sturdy and rounded off



**b) KURA Form** ▶ the tailor-made one

**fits perfectly!**

- dimensionally accurate projected solutions for surfaces with one or more adjoining rectangular areas
- exactly fitting mats with an easily understandable installation plan  
→ easy installation – practically no cutting work – no cut-off

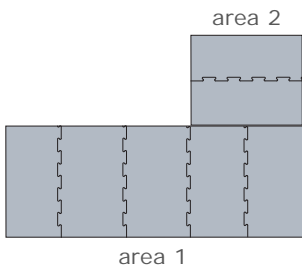

(for technical reasons the adjoining areas do not have puzzle-shaped sides as standard)



e.g. fitting to all parlour types

**c) KURA Rotary** ▶ in the rotary parlour carousel

- tailor-made for each rotary parlour carousel
- can be installed piece by piece between milking times





▶ The pediKURA® system enhances the soft rubber floorings with selective “abrasion zones”, very similar to conditions in nature, where sandy constituents in the elastic soil ensure that horn formation and abrasion are kept balanced.

Natural ground is soft, sufficiently non-slippery and maintains the claws



**pediKURA® system**

▶ claw-friendly and more slip resistant covering with an abrasive surface for walking areas (slatted and paved floors)

in combination with the well-proven, soft KURA coverings

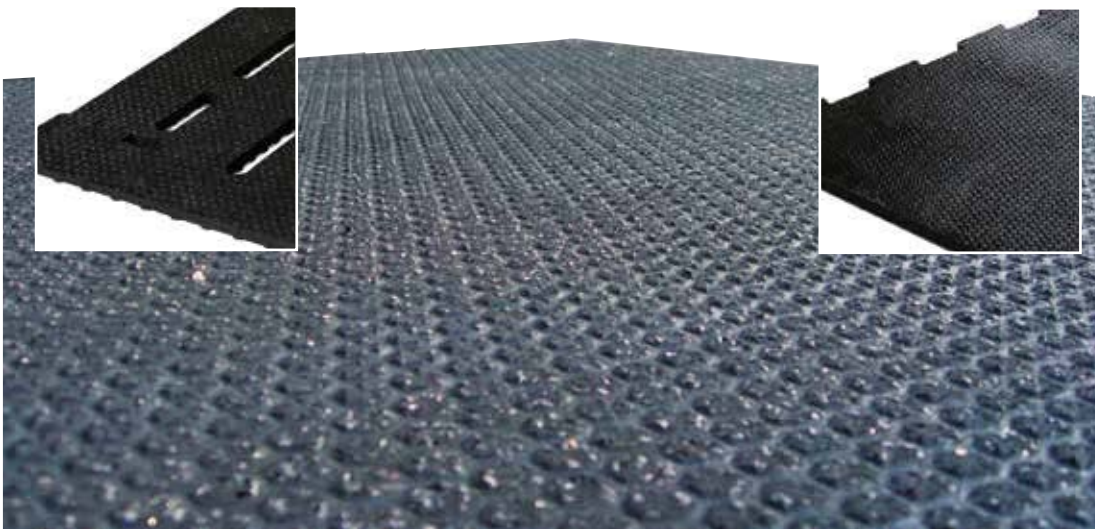

coverage of 20 % pediKURA® in the cow house: last claw trimming 4 months before

- as a modular system can be combined with all **KURA** products
- selective abrasion zones will be established → abrasion is controllable
- supports the natural balance between horn formation and abrasion → contributes to correct claw form
- ideal softness and slip resistance in **all parts** of the cow house
- retrofitting easily possible
- compatible with use of manure scraper, robot scraper and wheeled traffic\*

**About corundum:**

- ▶ corundum is the **second hardest mineral** after diamonds
- ▶ corundum does not react with acids and bases: best precondition for use in slurry environments
- ▶ patented technology which has been well-proven in the KRAIBURG-group for many years



surface with incorporated abrasive corundum and special profiling: supports claw abrasion



stud profile for ideal softness

\* Please take notice of the corresponding KRAIBURG specifications. You will obtain these at your local KRAIBURG dealer or at [www.kraiburg-elastik.com](http://www.kraiburg-elastik.com).



## pediKURA® - installation

■ basically the floor surface is completely covered with the well-proven, soft KRAIBURG KURA

■ 20 % of this will be covered with pediKURA®

→ predominantly heavily frequented sections like crossovers, area around drinking bowls and cow brushes, parlour entrance and exit, ...

(The area where the cows stand while feeding on the feed alley should be covered exclusively with KURA.)

### Example:

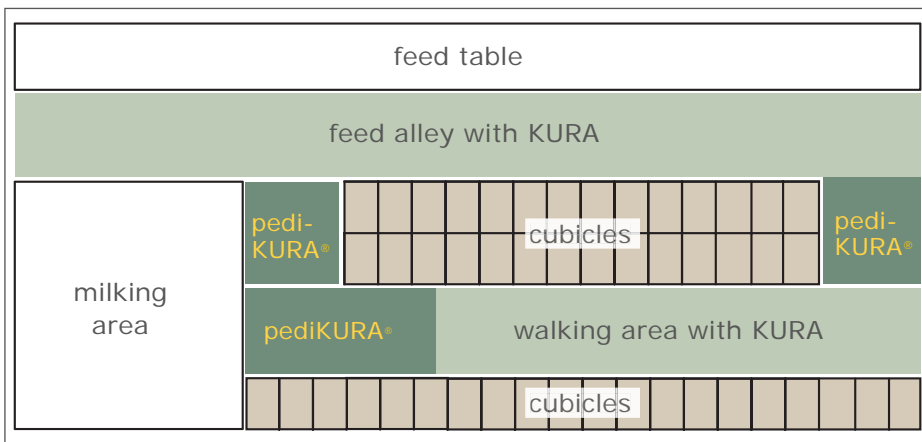

### Options and Dimensions:

	range of use:	lower side profile:	thickness:	width:	length:
pediKURA® S	slatted floor	studs (5 mm)	24 mm	tailor-made	
pediKURA® P	paved/concrete floor with scraper			in 2 cm increments from 96 cm to 500 cm*	125 cm
pediKURA® Form	paved/concrete floor without scraper			tailor-made	

Further details and guidelines: see KURA S, KURA P or KURA Form.

\*starting at a width of 220 cm, mats are puzzled together

**To take full advantage of our product, please be aware of the following:**

**pediKURA® maintains the claw form, but claw trimming is still necessary!**

► Claws must still be trimmed regularly, but only for the purpose of claw care and less for position correction or complex treatment.

We recommend functional claw trimming **4 to 6 weeks before pediKURA® is installed.**

**Important: do not install pediKURA® at the same time you trim claws,** because the claw has to become accustomed to the abrasion.

#### ideal claw form

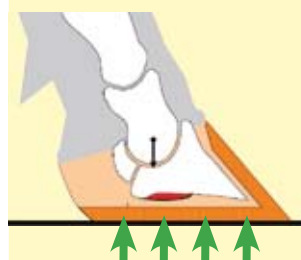

optimal load conditions

Check the claws with the KRAIBURG pediKURA® Tester!



available at your local dealer or directly at KRAIBURG.

## ergoMILK ▶ the ergonomic mat for the milking pit

Cow comfort – naturally!  
And what about man?



- feels pleasantly soft underfoot
- slip-resistant diamond surface → elastic and secure underfoot
- heat insulating
- easy to clean and disinfect



surface: slip-resistant and deformable diamond profile



lower side profile: 5 mm high, deformable studs



puzzle: the clean seam

### Dimensions:

**lower side profile:** studs (5 mm)

**thickness:** 17 mm

12 mm 17 mm

**puzzle shaped edges on the 2 long sides:**

**width:**  
95 cm

**length:**  
173/350 cm

**puzzle shaped edges on 4 sides:**

95 cm

170 cm

### ▶ Prerequisites / tips on installation:

- subsurface must be even and clean
- lay out using floating method (no plugging and further fastening)
- lay out mats, do not press them together (join loosely)
- lay out completely to avoid stumbling edges!
- maintain a 2 to 15 cm distance to the edge (side wall) → cleaning gutter
- for adjustments at site, the mats can easily be cut with a sharp knife  
tip: moisten the knife and cut along a guide batten laid against the mat

**LOSPA swiss** ▶ for heifers in fully-slatted pens / two-area pens (with separate lying area)



▶ **Tailor-made for every slatted floor geometry**

The mats are generally dimensioned according to the guidelines established by our specialists. The slatted floor must be suited for covering with KRAIBURG mats\*.

- increased lying comfort
- improved heat insulation
- with reinforced surface for high stress
- compatible with use of manure scraper, robot scraper and wheeled traffic\*



reinforced **grip-surface** for high stress

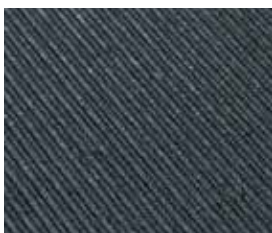

**stable groove profile on lower side** for high stress



**fastening element:** patented rubber peg to prevent lateral slipping - flush with the mat



**Dimensions:**

<b>lower side profile:</b>	<b>thickness:</b>	<b>width and length:</b>	20 mm
grooves	20 mm	taylor-made	

For young cattle up to 250 kg liveweight KURA S can also be used (see page 20).

**Important prerequisites for slatted floors:**

**slit width:** starting at 24 mm

**slat width within concrete elements:** For satisfactory cleanness of the animals, slat widths up to 140 mm are recommended. **We will be glad to advise you!**

**IMPORTANT:** Balanced feeding is a requirement for clean animals.

\* Please take notice of the corresponding KRAIBURG specifications. You will obtain these at your local KRAIBURG dealer or at [www.kraiburg-elastik.com](http://www.kraiburg-elastik.com).

VITA

Softness: ★★★★★



- the three functional layers (rubber-foam-rubber) ensure optimal and permanent softness for every load condition
- softness enhances slip resistance - also for the calf
- heat insulating
- seamless top covering
  - ▶ easy to clean
  - ▶ optimal hygiene
- frame profile surrounds the system
- covering strip for „neat“ closure towards the wall
  - ▶ reduced soiling
- significantly reduced need for bedding



Dimensions:

<b>complete system:</b>	<b>thickness:</b> approx. 65 mm	<b>width x length:</b> maximum 525 x 600 cm	
consists of:			
<b>VITA LongLine</b>	<b>thickness:</b> 15 mm	<b>width x length:</b> 262/348/440/525 cm x 250 cm to 600 cm in 10 cm increments	
<b>KRAI-PUR</b>	<b>thickness:</b> 25 mm	<b>width:</b> 120 cm	<b>length:</b> 155 cm
<b>VITA Cup</b>	<b>thickness:</b> 25 mm	<b>width:</b> 120 cm	<b>length:</b> 135 cm
<b>VITA Top</b>	<b>height:</b> 5 cm	<b>width:</b> 5.5 cm	<b>length:</b> 200 cm
<b>VITA Border</b>	<b>height:</b> 6 cm	<b>width:</b> 7 cm	<b>length:</b> 240 cm



proven **pebbled profile** on upper and lower side

\* Please take notice of the corresponding KRAIBURG installation instructions with useful advice and tips. You will obtain these at your local KRAIBURG dealer or at [www.kraiburg-elastik.com](http://www.kraiburg-elastik.com).



**SIESTA**

Softness: ★ ★



- comfortable softness through air-cushion-like lower side profile
- dimensionally stable - durable - good slip resistance
- easy to clean and disinfect
- 4 sides with puzzle shaped edges → very simple and flexible installation
- compatible with wheeled traffic\*

**Dimensions:**

4 sides with puzzle shaped edges      **thickness:** 30 mm      **width:** 115 cm      **length:** 170 cm

**Installation:** 8 fixings / mat\*, in small pens up to approx. 15 m<sup>2</sup> SIESTA can be laid out using the floating method (i.e. without fastenings).

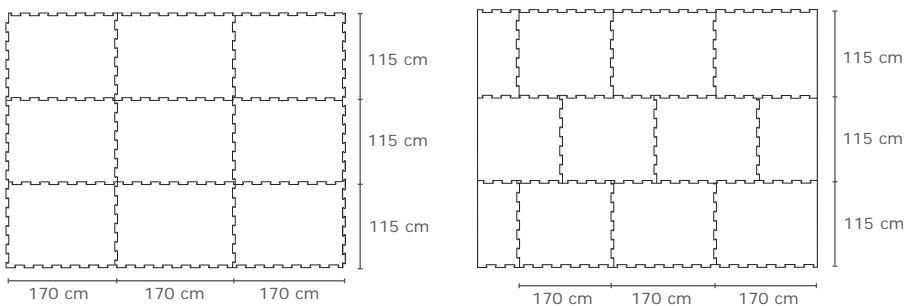
**Installation examples:**

\* Please take notice of the corresponding KRAIBURG specifications. You will obtain these at your local KRAIBURG dealer or at [www.kraiburg-elastik.com](http://www.kraiburg-elastik.com).

**LENTA**

Softness: ★★



- optimal softness through double structured stud profile
- rugged, dimensionally stable and durable
- integrated slope to rear edge improves drying off
- dirt barriers reduce soiling underneath the mat



double structured stud profile at lower side



**chamfer at rear edge:**  
gentle on animal joints,  
no stumbling edges

**feed stalls:**  
especially suited due to  
**high dimensional stability**  
and **integrated slope**  
**to rear edge**  
(special mat length 157 cm)



## Dimensions:

19 mm  30 mm

thickness:	width:	length:
30 mm	100 cm	150/157/165/175/185 cm
	110 cm	150/157/165/175/185/200 cm
	120/130 cm	150/157/165/175/185/200/220 cm

**Installation:** 3 fixings / mat\*

**Accessory:**

**KK-Poly-T-Bar** for covering joint widths of 40 - 80 mm or for closure at side edges, **length:** 120/165/180 cm

\* Please take notice of the corresponding KRAIBURG installation instructions with useful advice and tips. You will obtain these at your local KRAIBURG dealer or at [www.kraiburg-elastik.com](http://www.kraiburg-elastik.com).

**KEN / KEN Puzzle**

Softness: ★



- lower side with simple studs gives softness
- rugged, dimensionally stable and durable
- can be variably adjusted in length and width if required



lower side

**options:**



with straight edges



with puzzle shaped edges

**Dimensions:**



<b>thickness:</b> 20 mm	<b>KEN (straight edges):</b>	
	<b>width:</b>	<b>length:</b>
	90 cm	130/140/150/165 cm
	100 cm	130/140/150/165/175/185/200/220/350 cm
	110 cm	140/150/165/175/185/200/220/350 cm
	120 cm	150/165/170/175/180/185/200/220/350 cm
130 cm	150/165/175/185/200/220/350 cm	

<b>KEN Puzzle:</b>	
<b>width:</b>	<b>length:</b>
105 cm	140/150/165/175/185 cm
115 cm	140/150/165/175/185/200 cm
125 cm	150/165/175/185/200 cm

**Installation:** 3 fixings / mat\*

\* Please take notice of the corresponding KRAIBURG installation instructions with useful advice and tips. You will obtain these at your local KRAIBURG dealer or at [www.kraiburg-elastik.com](http://www.kraiburg-elastik.com).



English

Your KRAIBURG dealer:

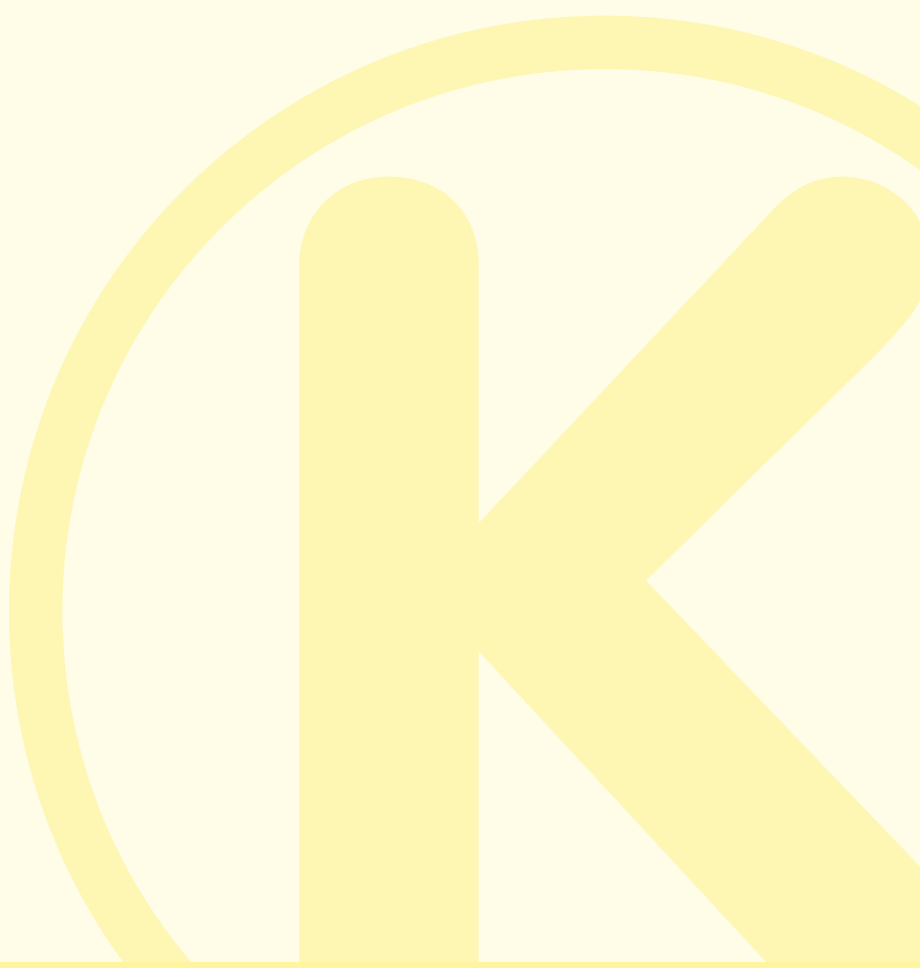

**Gummiwerk KRAIBURG  
Elastik GmbH & Co. KG**

Göllstraße 8  
84529 Tittmoning  
GERMANY  
Tel: +49/86 83/701- 303  
Fax: +49/86 83/701- 190  
e-mail: [info@kraiburg-elastik.de](mailto:info@kraiburg-elastik.de)  
[www.kraiburg-elastik.com](http://www.kraiburg-elastik.com)

09/2013



► brings the pasture indoors

[www.kraiburg-elastik.com](http://www.kraiburg-elastik.com)

